

**Current  
great prices!**

# ALUFIX

Modular Clamping Systems



Basic kits 2021

Fixed on precision





# Witte Barskamp: Fixed on precision



**F**ounded in 1969 as a manufacturing partner for high-precision components in the aerospace industry, Witte Barskamp is today one of the leading international developers and manufacturers of modular fixturing, positioning and measuring devices as well as feeder systems. With the ALUFIX modular fixturing system and versatile vacuum clamping systems, Witte is considered the global market leader.

Subsidiaries in Singapore, Mexico, USA and Brazil as well as the vast professional representation partner network across the globe ensure access to Witte products and services worldwide.

Almost all major companies in the automotive and aerospace industries rely on products and application solutions from Witte. Additionally, the products and solutions find applications in a wide range of industries including, measuring, medical technology, as well as in all other industries in which dimensional quality monitoring and precision plays a decisive role.

In the past 50 years Witte has accumulated more than 250 patents, registered designs and wordmarks of which 70 are still current and active today. Many of them for ALUFIX – the market recognized brand for high precision, durable, modular fixturing.

## Contents

Page	Item
2	<b>Starter Kits A - F</b> ALUFIX Classic
4	<b>Starter Kit G</b> Basic Set 23 pieces
5	<b>Basic Set AF 16</b> 75 Teile
6	<b>Basic Set 1 AF25</b> 67 Teile
7	<b>Basic Set 2 AF25</b> 103 Teile
8	<b>Basic Set 3 AF25</b> 105 Teile
9	<b>Basic Set 4 AF25</b> 228 Teile
10	<b>Basic Set 5 AF25</b> 344 Teile
11	<b>Basic Set 6 AF25</b> 332 Teile
12	<b>Basic Set 7 AF25</b> 418 Teile
13	<b>Basic Set 9 AF25</b> 434 Teile
14	<b>Extension Set 1 &amp; 2 AF25</b> 97 / 143 Teile
15	<b>Extension Set 3 AF25</b> 209 Teile
16	<b>Storage items</b>

## ALUFIX CLASSIC Starter Kits

Fast clamping with ALUFIX



### STARTER KIT A

#### #83131 Screw clamp

with ball joint, foot plate and extension, 371g

- max clamping width 25 mm
- extension 100 mm

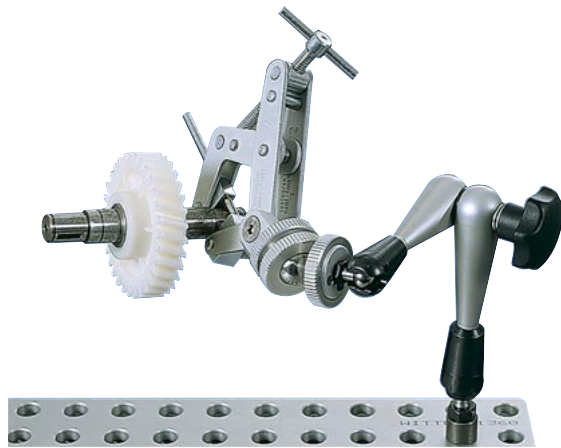

### STARTER KIT B

#### #83132 Screw clamp

with ball joint, swivel arm and screw clamp, 936g

- max clamping width 50 mm
- arm length 280 mm (2x140)
- hydraulic central clamping
- workpiece can be fixed in any position

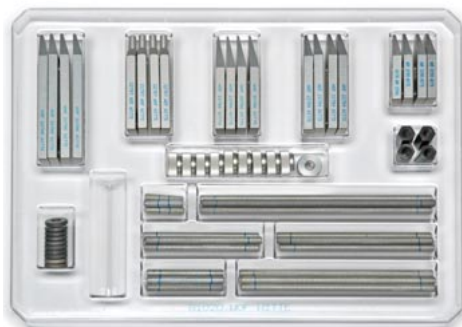

### STARTER KIT C

#### #81020 Spannelementesatz M6, 69 Teile, 650g

Bestehend aus:

- 20 Spannpratzen in div. Formen, L. von 45 bis 85mm
- 24 Gewindestücke M6 in 6 Längen von 25 bis 150mm
- 4 Verlängerungsmuttern, 10 Muttern und 10 Scheiben

## STARTER KIT D

**#83134 Hold down spring**

and hold down stud with M6 thread, 40g

Comprising:

- Hold down spring L=60mm
- Hold down stud L=60mm (other length on request)
- One reducer sleeve each with thread M8, M10 und M12



## STARTER KIT E

**#83135 Vise**

with pins, jaw width 50 mm, 810g

- high tensile aluminium
- exchangeable jaws
- clamping width 65 mm

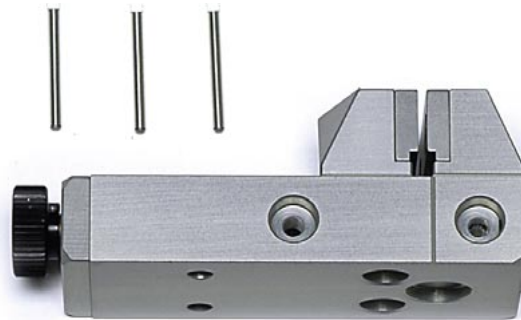

## STARTER KIT F

**#82080 Keyless chuck**

with reversible jaws, D80, 368g

- high tensile aluminium
- centric clamping
- diameter 80mm



ALUFIX CLASSIC elements can be anodized in different colours. The colour natural is standard, black (-1) is available as an alternative. Other colours on request.

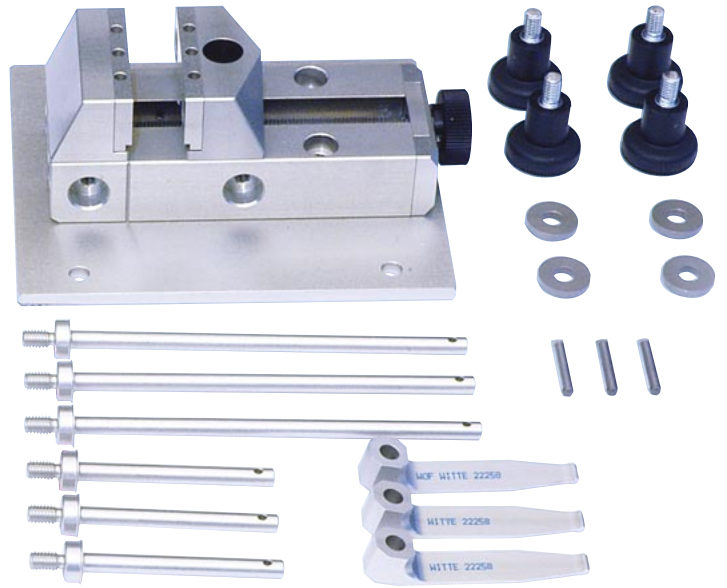
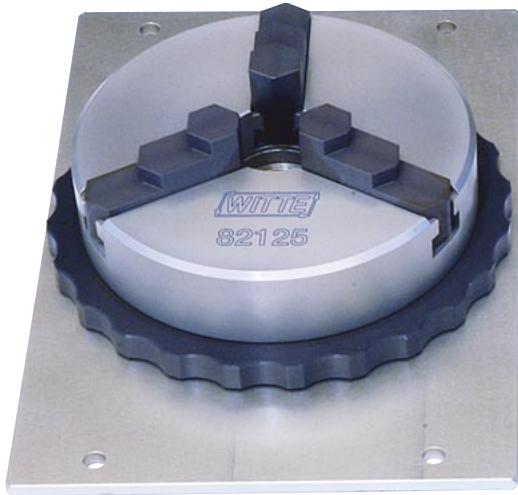

**STARTER KIT G**

**#96092 Basic Set**  
 Clamp accessory kit for measuring machines  
 (23-pcs), 9,8 kg

Nr.	Qty.	Name
96106	1	Keyless chuck $\varnothing$ 125, 3 jaws
96107	1	Vise 50 AF25
24605	3	Pin for vise AF25
22258	3	Hod down spring
54766	3	Hold down stud AF25
54767	3	Hold down stud AF25
13086	4	Screw with knurled grip
21286	4	Washer $\varnothing$ 6,4
96315	1	Storage box with inlay

Keyless chuck and vise mounted on aluminium plate



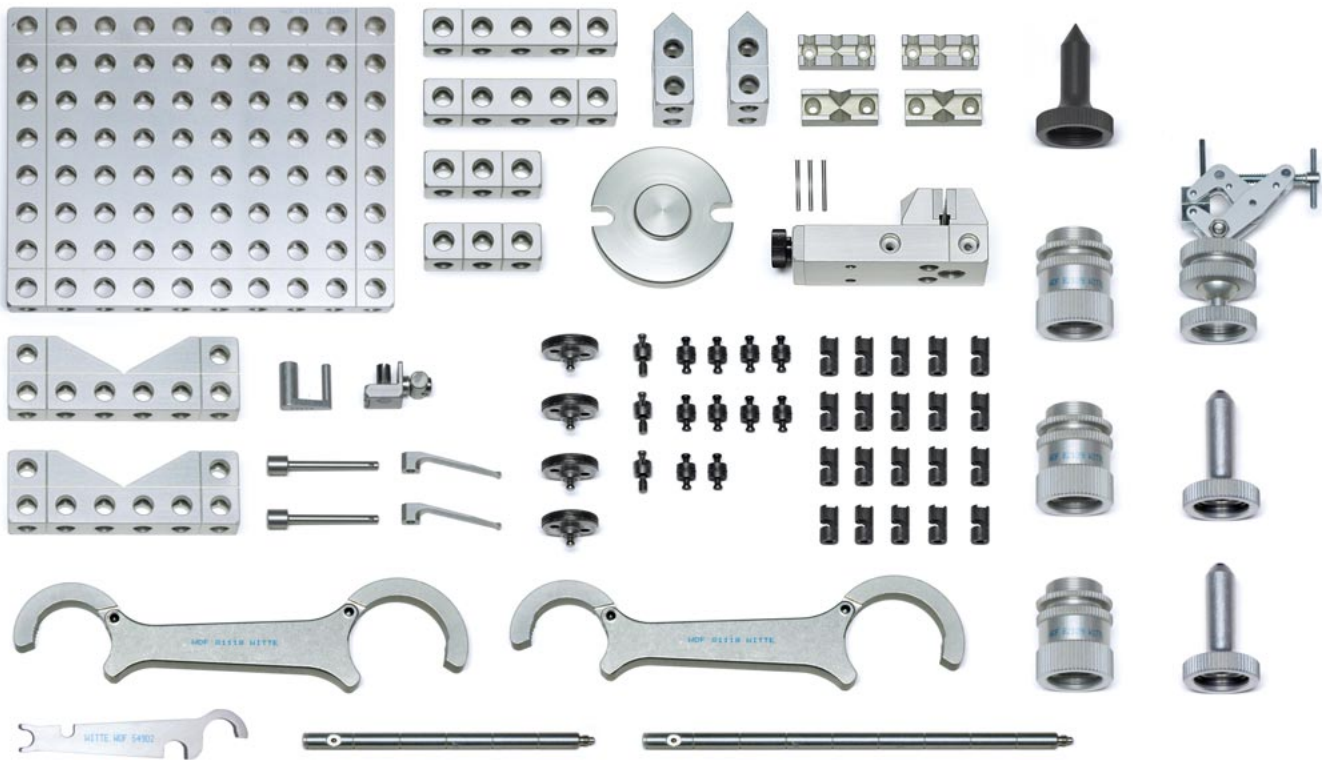

### #90271 Basic Set Alufix 16, medium (75-pcs), 2,3 kg

Nr.	Qty.	Name
21573	1	Base plate 16x96x160
21586	2	Bar 16x16x80
21584	2	Bar 16x16x48
22173	2	V Block 90°
82672	1	Quick connector set (36-pcs)
81492	1	Tools (4-pcs)
82139	3	Screw-jack h38-50
23252	1	Bolt disk with stud
21670	1	Universal plate

Nr.	Qty.	Name
21646	1	Center, long
80584	2	Center with ball
21988	2	V piece 120°
80925	1	Screw clamp w ball joint
80742	1	Winder
22274	1	Deflector
20244	2	Hold down spring
20338	2	Hold down stud
81790	1	Vise set with flat and V jaws (11-pcs)

ALUFIX CLASSIC elements can be anodized in different colours. The colour natural is standard, black (-1) is available as an alternative. Other colours on request.

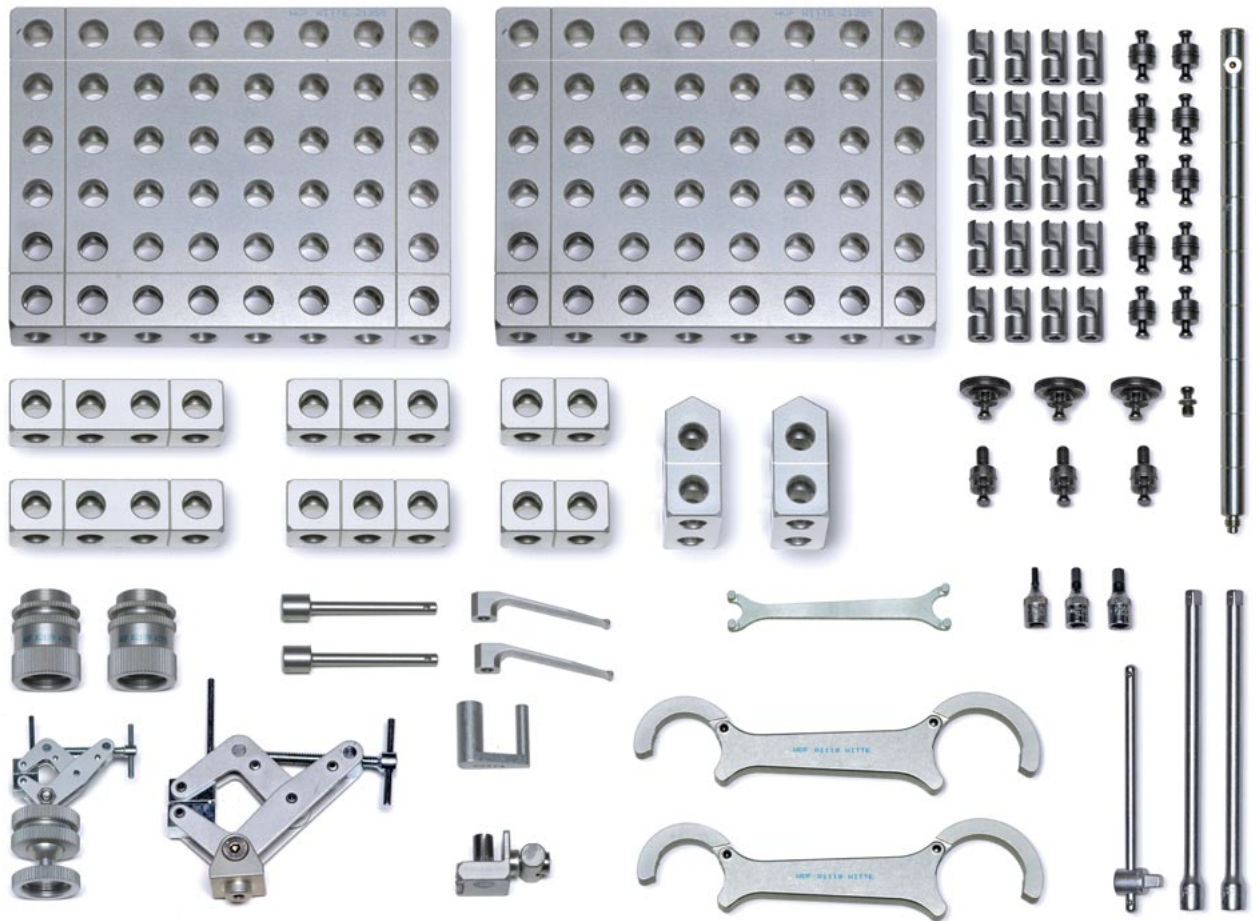

**#90274 Basic Set 1**  
Alufix 25 (67-pcs), 4,5 kg

Nr.	Qty.	Name
21352	2	Base plate 25x150x200
21373	2	Bar 25x25x50
21374	2	Bar 25x25x75
21375	2	Bar 25x25x100
22256	2	Delta block 120° Form 3
82673	1	Quick connector set (36 pcs)
21500	1	Bolt, shortened for thread
81493	1	Tools (10 pcs)

Nr.	Qty.	Name
82139	2	Screw-jack h38-50
80925	1	Screw clamp with ball joint
80924	1	Screw clamp with joint
22258	2	Hold down spring
22260	2	Hold down stud
80743	1	Winder
22275	1	Deflector



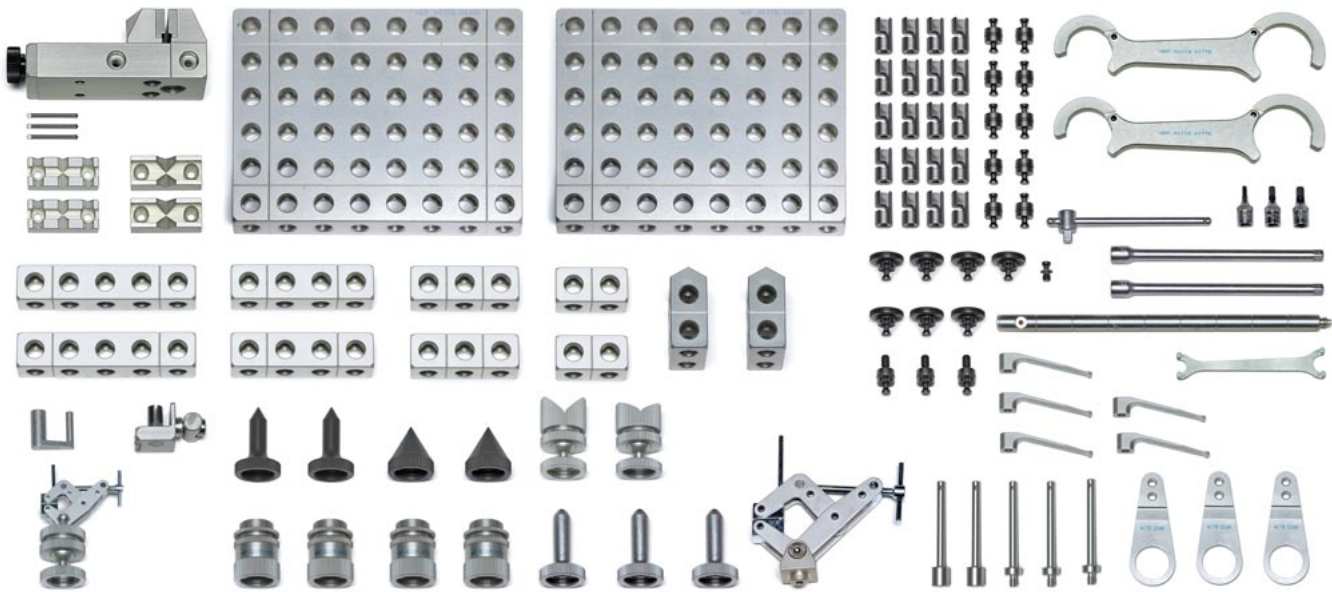

**#90275 Basic Set 2**  
Alufix 25 (104-pcs), 5,9 kg

Nr.	Qty.	Name	Nr.	Qty.	Name
21352	2	Base plate 25x150x200	21646	2	Center
21373	2	Bar 25x25x50	80584	3	Center with ball
21374	2	Bar 25x25x75	80733	1	V piece 120° with ball joint
21375	2	Bar 25x25x100	80725	1	V piece 90° with ball joint
21376	2	Bar 25x25x125	80925	1	Screw clamp with ball joint
22256	2	Delta block 120° Form 3	81791	1	Vise Set 50mm (11 pcs)
82673	1	Quick connector set (36 pcs)	22258	5	Hold down spring
21500	1	Bolt, shortened for thread	22260	2	Hold down stud
81493	1	Tools (10 pcs)	22263	3	Hold down stud
82139	4	Screw-jack h38-50	22268	3	Traverse holder with heel
23239	4	Bolt disk with stud	80743	1	Winder
80924	1	Screw clamp with joint	22275	1	Deflector
21644	2	Center			

ALUFIX CLASSIC elements can be anodized in different colours. The colour natural is standard, black (-1) is available as an alternative. Other colours on request.

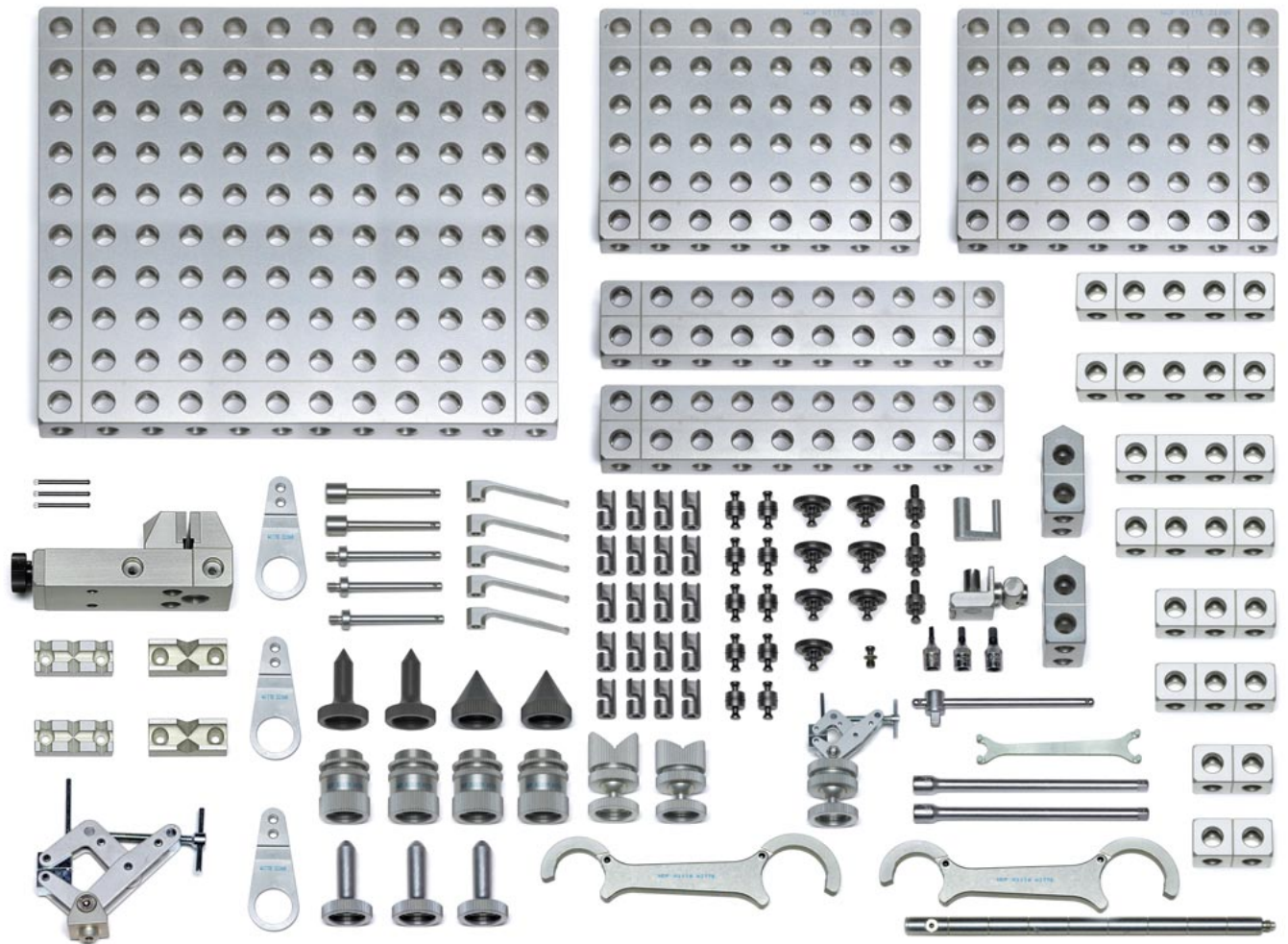

**#90276 Basic Set 3**  
Alufix 25 (106-pcs), 12,6 kg

Nr.	Qty.	Name
21360	1	Base plate 25x250x300
22885	2	Base plate 25x50x250
21352	2	Base plate 25x150x200
21373	2	Bar 25x25x50
21374	2	Bar 25x25x75
21375	2	Bar 25x25x100
21376	2	Bar 25x25x125
22256	2	Delta block 120° Form 3
82673	1	Quick connector set (36 pcs)
21500	1	Bolt, shortened for thread
81493	1	Tools (10 pcs)
82139	4	Screw-jack h38-50
23239	1	Bolt disk
80925	2	Screw clamp with ball joint

Nr.	Qty.	Name
21644	2	Center, short
21646	2	Center, long
80733	1	V piece 120° with ball joint
80725	1	V piece 90° with ball joint
81791	1	Vise Set 50mm (11 pcs)
22258	5	Hold down spring
22260	2	Hold down stud
22263	3	Hold down stud
22268	3	Traverse holder with heel
80743	1	Winder
22275	1	Deflector
80924	1	Screw clamp with joint
80584	3	Center with Ball D6/M24
12584	1	Storage case



Aluminium case #12584,  
without inlays,  
version may be different to case shown,  
included in supply free of charge

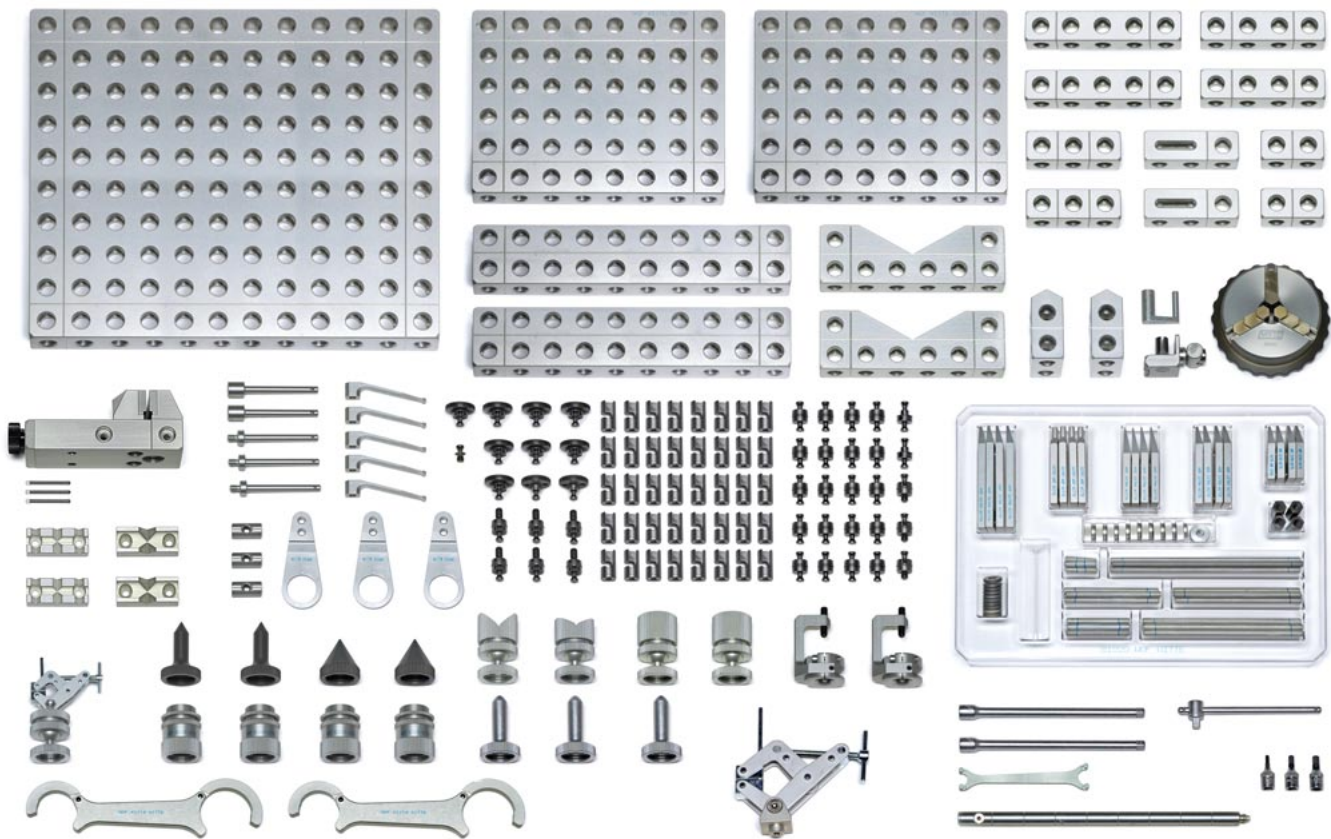

### #90277 Basic Set 4

Alufix 25 (229-pcs), 15,5kg

Nr.	Qty.	Name
21360	1	Base plate 25x250x300
21352	2	Base plate 25x150x200
22885	2	Base plate 25x50x250
21376	2	Bar 25x25x125
21375	2	Bar 25x25x100
21374	2	Bar 25x25x75
21373	2	Bar 25x25x50
23233	2	Bar 1D
21987	2	V block 120°
22256	2	Delta block 120° Form 3
82673	2	Quick connector set (36-pcs)
21500	1	Bolt, shortened for thread
25654	3	Bolt f. grid plate + keyless chuck
23228	2	Twin bolt for bar 1D/2D
23241	2	Bolt disk
80531	3	Crosspiece nut
81493	1	Tools (10-pcs)
82139	4	Screw-jack h38-50
23239	1	Bolt disk

Nr.	Qty.	Name
21644	2	Center, short
21646	2	Center, long
80584	3	Center with ball
80941	2	Magnetic holder with ball joint
80733	1	V piece 120° with ball joint
80725	1	V piece 90° with ball joint
81111	2	C clamp adjustable
80925	1	Screw clamp with ball joint
81791	1	Vise Set 50mm (11-pcs)
82080	1	3 jaw keyless chuck compl. ø80
22258	5	Hold down spring
22260	2	Hold down stud
22263	3	Hold down stud
22268	3	Traverse holder with heel
80743	1	Winder
22275	1	Deflector
80924	1	Screw clamp with joint
81020	1	Clamp Set 9 M6S (69-pcs)
12584	1	Storage case



Aluminium case #12584, without inlays, version may be different to case shown, included in supply free of charge

ALUFIX CLASSIC elements can be anodized in different colours. The colour natural is standard, black (-1) is available as an alternative. Other colours on request.

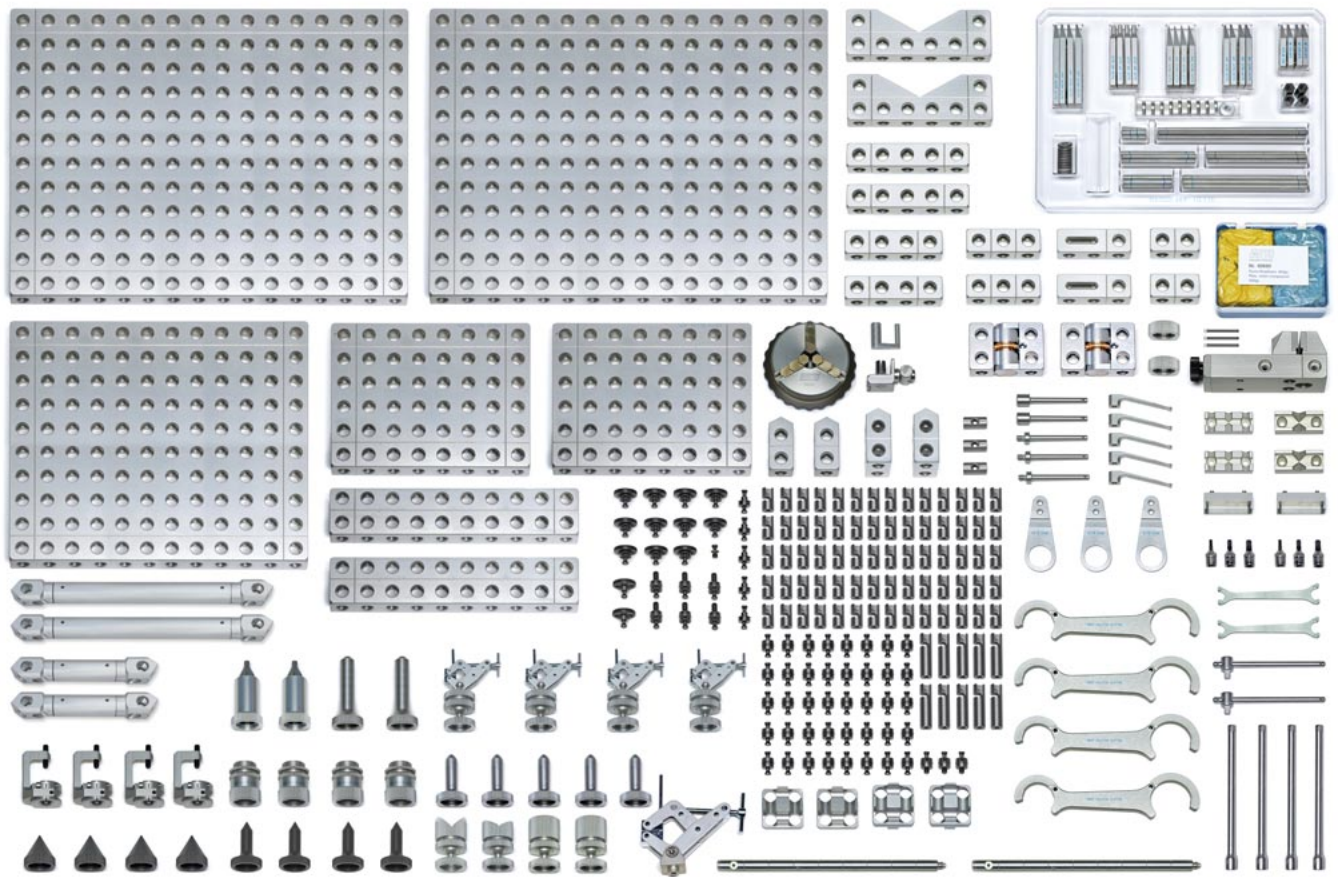
**#90278 Basic Set 5**

Alufix 25 (345-pcs), 49,8 kg

Nr.	Qty.	Name	Nr.	Qty.	Name
21361	2	Base plate 25x300x400	21644	4	Center, short
21360	1	Base plate 25x250x300	21646	4	Center, long
21352	2	Base plate 25x150x200	80584	5	Center with ball
22885	2	Base plate 25x50x250	80733	1	V piece 120° with ball joint
21376	2	Bar 25x25x125	80725	1	V piece 90° with ball joint
21375	2	Bar 25x25x100	80661	2	True line stud
21374	2	Bar 25x25x75	80941	2	Magnetic holder with ball joint
21373	2	Bar 25x25x50	81212	2	Autocenter
81443	2	Strut 25x25x125	81111	4	C clamp adjustable
81444	2	Strut 25x25x250	80925	4	Screw clamp with ball joint
23233	2	Bar 1D	22005	2	Moulding cap
81028	2	Double knuckle	81791	1	Vise Set 50mm (11 pcs)
21987	2	V block 120°	80685	1	Compound resin 400g
22256	2	Delta block 120° Form 3	81832	2	Forming jaw with bushes (3 pcs)
22253	2	Delta block 120° Form 2	82080	1	3 jaw keyless chuck compl. ø80
81285	1	Quick connector set (70-pcs)	22258	5	Hold down spring
82673	2	Quick connector set (36-pcs)	22260	2	Hold down stud
80531	3	Crosspiece nut	22263	3	Hold down stud
23228	2	Bolt for bar 1D/2D	22268	3	Traverse holder for stud
25654	3	Bolt f. grid plate + keyless chuck	80743	1	Winder
21500	1	Bolt, shortened for thread	22275	1	Deflector
81493	2	Tools (10-pcs)	80924	1	Screw clamp with joint
82139	4	Screw-jack h38-50	80604	2	Base for screw clamp
23239	1	Bolt disk	81020	1	Clamp Set 9 M6S (69 pcs)
23241	2	Bolt disk	12584	1	Storage case

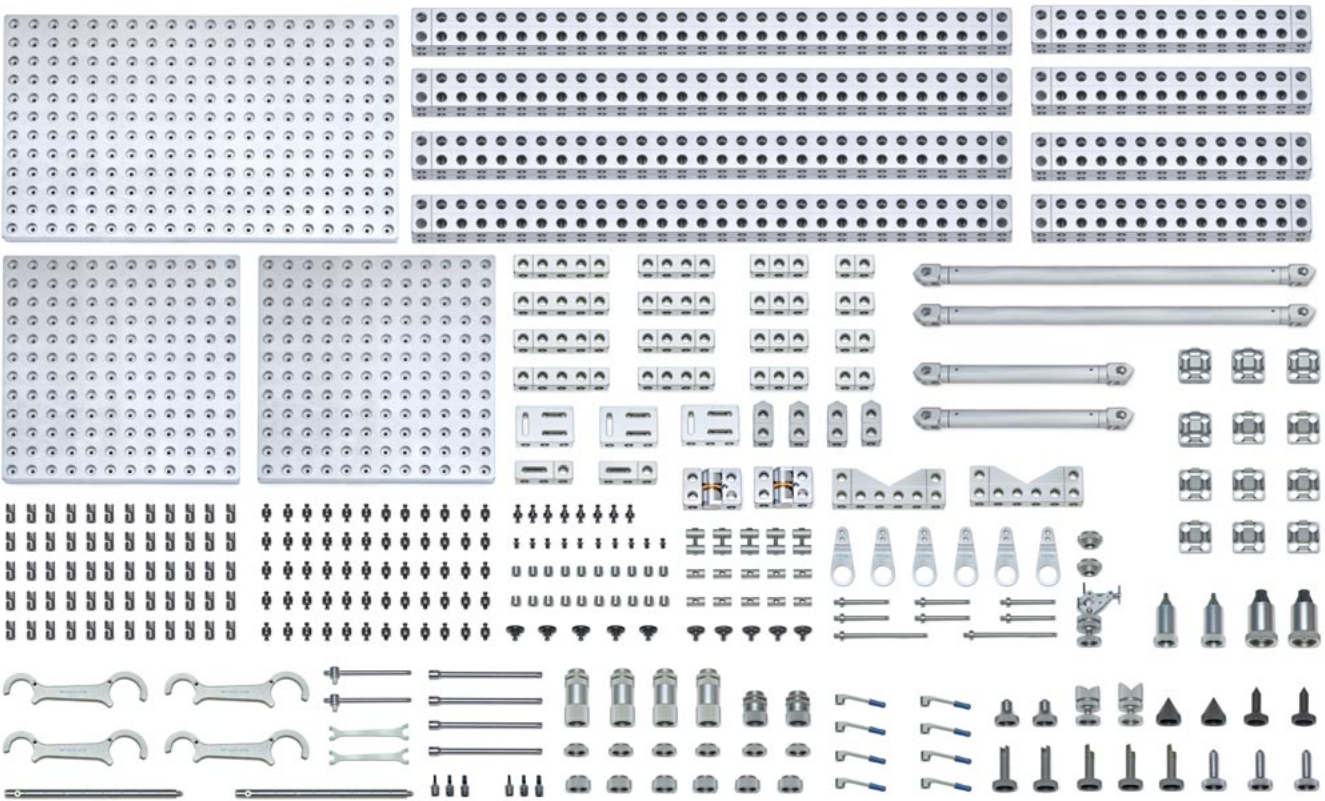

Supply includes  
3 cross guiding slides with slide stop  
#82437 (not shown above)



### #98156 Basic Set 6

Alufix 25 (332-pcs), 49,8 kg

Nr.	Qty.	Name
33502	1	Base plate 25x300x500 AF25
56492	2	Base plate 25x300x300 AF25
21373	4	Bar 25x25x50 AF25
21374	4	Bar 25x25x75 AF25
21375	4	Bar 25x25x100 AF25
21376	4	Bar 25x25x125 AF25
21824	4	Bar 50x50x750 Light AF25
24246	4	Bar 50x50x350 Light AF25
23325	8	Coupling 50x50 single AF25
23330	4	Coupling 50x50 double AF25
23233	2	Bar 25x25x75 1D AF25
23232	3	Base plate 2D 25x50x75 AF25
81028	2	Double knuckle AF25
82437	3	Cross guiding slide, AF25 with stop
81444	2	Strut 250 AF25
81327	2	Strut 500 AF25
21987	2	V-Block 120° 25x50x150 AF25
22253	4	Deltablock 120° Form2 AF25
23240	60	Lock SW5 AF25
23223	30	Twin bolt AF25
25743	30	Combi bolt shortened AF25
21500	10	Bolt shortened AF25
23228	8	Twin bolt AF25 for Bar 1D/2D
21386	10	Positioning sleeve ø12,5
81493	2	Tool AF25 (10pcs)
21385	10	Positioning sleeve ø12,5 AF25

Nr.	Qty.	Name
23241	5	Bolt disk ø6,7/M24 AF25
80701	10	Connector Set M6/25 AF25
82139	2	Screw-jack h=38/50 M24X1
82033	4	Screw-jack h=70/105 M24X1
20628	6	Screw-jack extension 6/M24x1
23286	6	Screw-jack extension 12/M24x1
23239	5	Bolt Disk with stud ø12,5/M24
21644	2	Center ø32/M24
21646	2	Center, ø12,5/M24 50 long
94543	2	Autocenter, star shaped, M24x1
95532	2	Autocenter, star shaped, M24x1
81112	3	Stop and support 180° AF25
81113	2	Stop and support 90° AF25
80531	10	Nut M6/25 AF25
80585	3	Center w. ball ø8/M24
80733	2	V Block 120° with ball joint
80590	2	True line stud ø15/M24/32,6
22647	2	Crossover male/male M24x1
93443	8	Hold down spring f.sens. surfaces
22263	6	Hold down stud M6 AF25
24885	2	Hold down stud M6 AF25 I125
22268	6	Traverse holder with heel 6/60
80743	1	Winder AF25
22275	1	Deflector AF25
80924	1	Screw clamp with ball joint

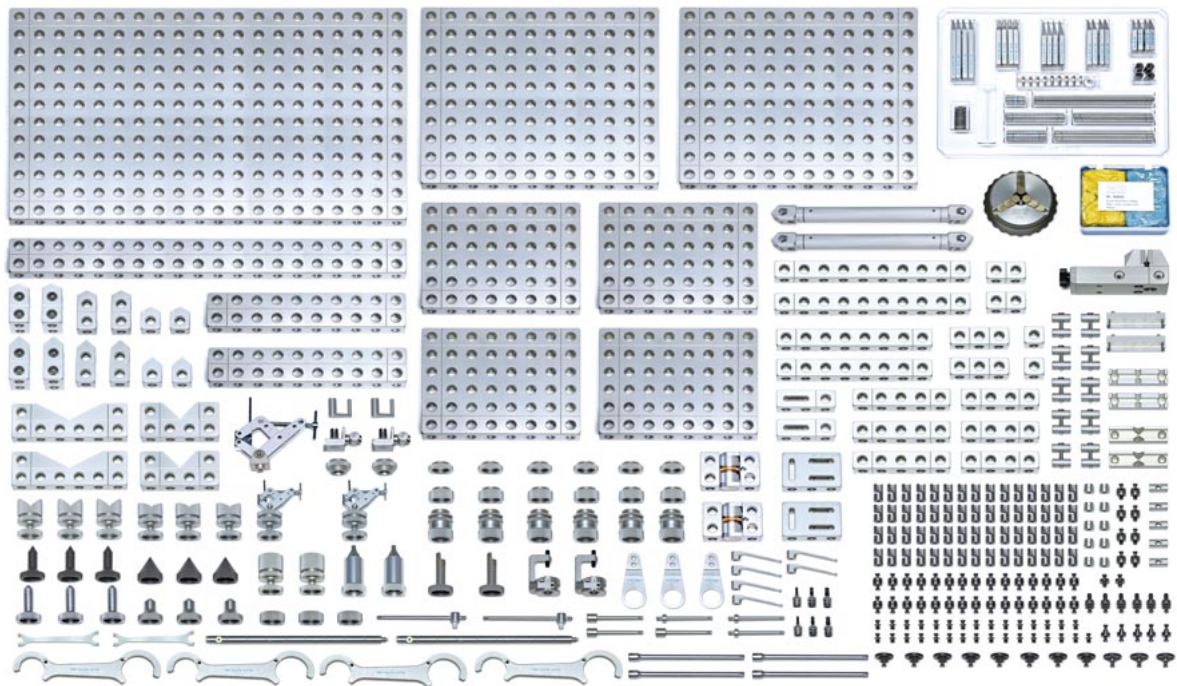

**#82689 Basic Set 7**  
Alufix 25 (419-pcs), 54 kg

Supply includes:  
2 cross roller slides #82462  
2 roller slides #82172  
(not shown above)



Nr.	Qty.	Name
22885	2	Base plate 25x50x250
21707	1	Base plate 25x50x500
21360	2	Base plate 25x250x300
21352	4	Base plate 25x150x200
21362	1	Base plate 25x300x500
21372	2	Bar 25x25x25
21373	2	Bar 25x25x50
21374	2	Bar 25x25x75
21375	3	Bar 25x25x100
21376	3	Bar 25x25x125
22963	2	Bar 25x25x200
22882	2	Bar 25x25x250
23233	2	Bar 1D
23232	2	Base plate 2D
81028	2	Double knuckle
82172	2	Roller slide
82462	2	Cross roller slide
81444	2	Strut 25x25x250
21992	2	V block 90°
21987	2	V block 120°
22235	2	Delta block 90° Form 1
22177	2	Delta block 90° Form 2
22174	2	Delta block 90° Form 3
22241	2	Delta block 120° Form 1
22253	2	Delta block 120° Form 2
22256	2	Delta block 120° Form 3
23240	60	Lock
23223	30	Twin bolt
21500	31	Bolt, shortened for thread
25654	2	Twin bolt for grid base plate
23225	6	Combi bolt
23228	5	Twin bolt for bar 1D
25743	8	Combi bolt shortened
81493	2	Tools (10 pcs)

Nr.	Qty.	Name
21385	10	Positioning sleeves
21869	6	Reducer bush
21714	5	Crosspiece nut
80701	10	Connecting set
82139	6	Screw-jack h38-50
20628	6	Screw-jack extension 6mm
23286	6	Screw-jack extension 12mm
23239	8	Bolt disk
23241	3	Bolt disk
21644	3	Center, short
21646	3	Center, long
80584	3	Center with ball
80733	3	V piece 120° with ball joint
80725	3	V block 90° with ball joint
80590	3	True line stud
80941	2	Magnetic holder with ball joint
81212	2	Auto-center
81112	2	Stop and support 180°
81111	2	C clamp adjustable
22644	3	Spacer
80925	2	Screw clamp with ball joint
22647	2	Cross over male/male
81792	1	Vise Set 75mm (11 pcs)
81833	2	Forming jaw with bushes (3 pcs)
80685	1	Compound resin 400g
82080	1	3 jaw keyless chuck compl. ø80
22258	6	Hold down spring
22260	3	Hold down stud
22263	3	Hold down stud
81020	1	Clamp set 9 M6S (69 Pcs.)
80924	1	Screw clamp 50 with joint
22268	3	Traverse holder with M6 heel
80743	2	Winder AF25
22275	2	Deflector AF25

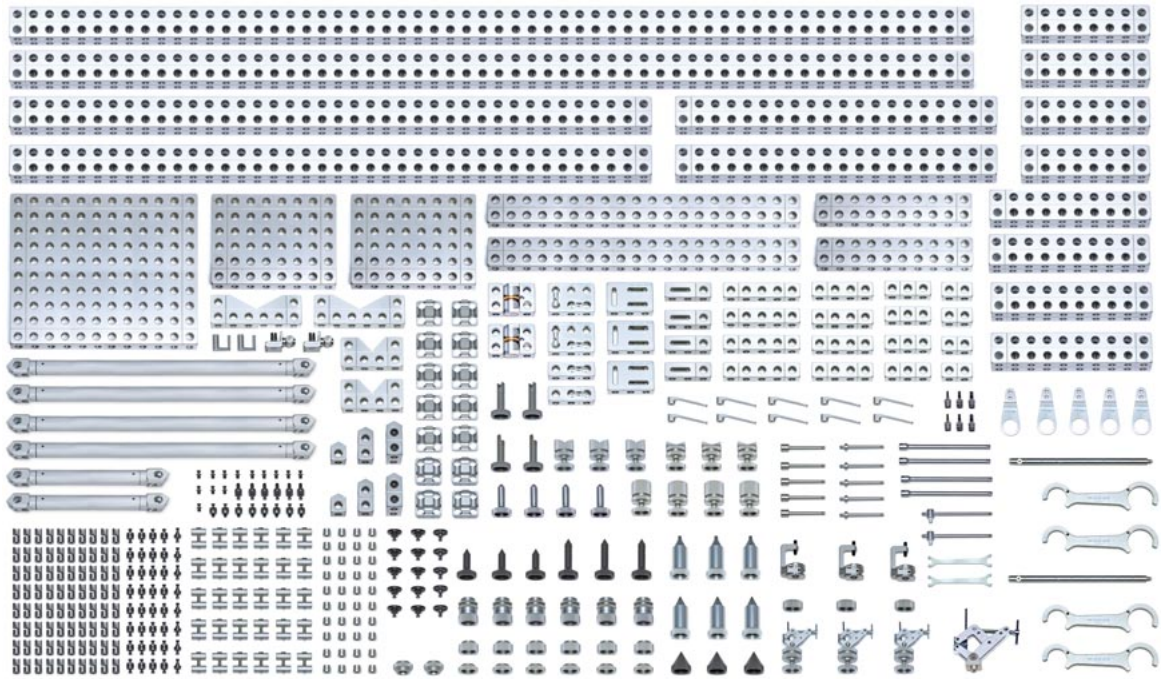

**#90281 Basic Set 9**  
Alufix 25 (434-pcs), 51kg

Supply includes:  
2 cross roller slides #82462  
2 roller slides #82172  
(not shown above)



Nr.	Qty.	Name
21360	1	Base plate 25x250x300
21352	2	Base plate 25x150x200
22885	2	Base plate 25x50x250
21707	2	Base plate 25x50x500
21373	4	Bar 25x25x50
21374	4	Bar 25x25x75
21375	4	Bar 25x25x100
21376	4	Bar 25x25x125
22949	4	Bar Light 50x50x250
22950	4	Bar Light 50x50x500
22951	2	Bar Light 50x50x1000
22952	2	Bar Light 50x50x1500
23325	10	Coupling, single
23330	4	Coupling, double
23233	4	Bar 1D
81021	2	Bar with 1 offset unit
23232	3	Base plate 2D
81023	2	Base plate with 2 offset units
81028	2	Double knuckle
82172	2	Roller slide
82462	2	Cross roller slide
81444	2	Strut 25x25x250
81327	4	Strut 25x25x500
21992	2	V Block 90°
21987	2	Block 120°
22241	2	Delta block 120° Form 1
22253	2	Delta block 120° Form 2
22256	2	Delta block 120° Form 3
23240	80	Lock
23225	6	Kombi bolt M6
23228	10	Twin bolt for bar 1D
23223	40	Twin bolt
21500	10	Bolt, shortened for thread

Nr.	Qty.	Name
25743	8	Combi bolt shortened
81493	2	Tools (10-pcs)
21385	40	Positioning sleeves
80701	30	Connection element M6
82139	6	Screw-jack h38-50
20628	6	Screw-jack extension 6mm
23286	6	Screw-jack extension 12mm
23239	10	Bolt disk
23241	5	Bolt disk
21644	3	Center, short
21646	3	Center, long 50
21648	2	Center, long 70
80584	4	Center with ball
80733	3	V Block 120° with ball joint
80927	3	Knife V 120° with ball joint
80941	4	Magnetic holder with ball joint
81212	3	Autocenter
82252	3	Autocenter
81112	2	Stop and support 180°
81113	2	Stop and support 90°
81111	3	C clamp adjustable
80925	3	Screw clamp with ball joint
22644	3	Spacer
22647	2	Cross over male/male
22258	10	Hold down spring
22260	5	Hold down stud
22263	5	Hold down stud
22268	5	Traverse holder for stud
80743	2	Winder
22275	2	Deflector
80924	1	Screw clamp with joint
80604	2	Base for toggle clamp



**#90283 Extension Set 1**  
Alufix 25 Light (97-pcs), 17 kg

Nr.	Stück	Name
20426	2	Bar Light 50x50x150
22949	2	Bar Light 50x50x250
22950	2	Bar Light 50x50x500
22951	2	Bar Light 50x50x1000
22952	2	Bar Light 50x50x1500

Nr.	Stück	Name
23330	4	Coupling, double
23325	8	Coupling, single
23240	50	Lock
23223	25	Twin bolt

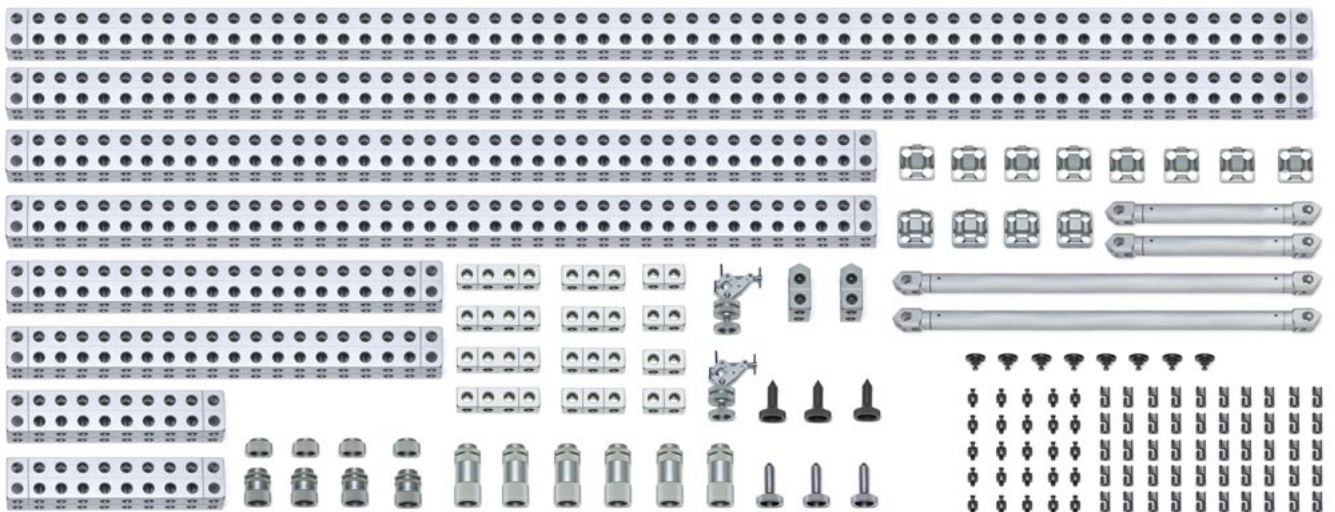

**#90284 Extension Set 2**  
Alufix 25 Light (143-pcs), 21 kg

Nr.	Qty.	Name
21373	4	Bar 25x25x50
21374	4	Bar 25x25x75
21375	4	Bar 25x25x100
22949	2	Bar Light 50x50x250
22950	2	Bar Light 50x50x500
22951	2	Bar Light 50x50x1000
22952	2	Bar Light 50x50x1500
23330	4	Coupling, double
23325	8	Coupling, single
81444	2	Strut 25x25x250
81327	2	Strut 25x25x500

Nr.	Qty.	Name
22256	2	Delta block 120° Form 3
23240	50	Lock
23223	25	Twin bolt
82139	4	Screw-jack h38-50
82033	6	Screw-jack h70-105
23286	4	Screw-jack extension 12mm
23239	8	Bolt disk
21646	3	Center
80584	3	Center with ball
80925	2	Screw clamp with ball joint



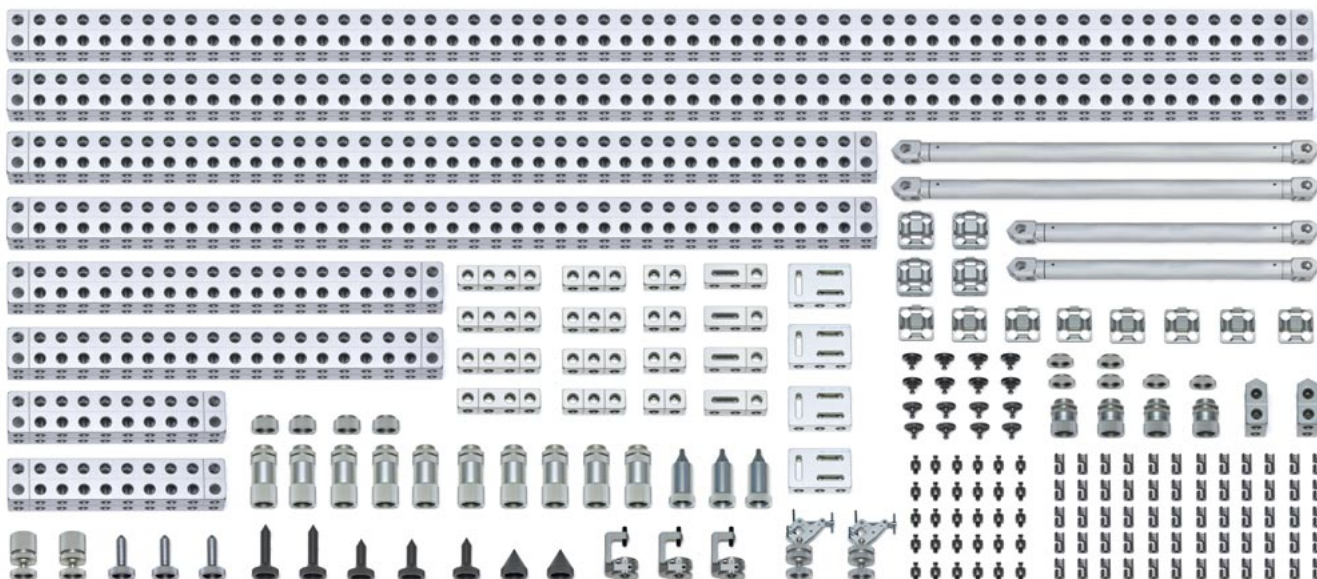

### #90285 Extension Set 3

Alufix 25 Light (209-pcs), 24,5 kg

Nr.	Qty.	Name
21373	4	Bar 25x25x50
21374	4	Bar 25x25x75
21375	4	Bar 25x25x100
22949	2	Bar Light 50x50x250
22950	2	Bar Light 50x50x500
22951	2	Bar Light 50x50x1000
22952	2	Bar Light 50x50x1500
23330	4	Coupling, double
23325	8	Coupling, single
23233	4	Bar 1D
23232	4	Base plate 2D
81028	2	Double knuckle
81445	2	Strut 25x25x375
81329	2	Strut 25x25x750
22256	2	Delta block 120° Form 3
23240	60	Lock

Nr.	Qty.	Name
23223	30	Twin bolt
23228	10	Twin bolt for bar 1D
82139	4	Screw-jack h38-50
82033	10	Screw-jack h70-105
20628	6	Screw-jack extension 6mm
23286	4	Screw-jack extension 12mm
23239	8	Bolt disk
23241	8	Bolt disk
21644	2	Center, short
21646	3	Center, long 50
21648	2	Center, long 70
80584	3	Center with ball
80941	4	Magnetic holder with ball joint
82252	2	Autocenter
81111	3	C clamp adjustable
80925	2	Screw clamp with ball joint

ALUFIX CLASSIC elements can be anodized in different colours. The colour natural is standard, black (-1) is available as an alternative. Other colours on request.



### Workstation, metal, lockable

#282562, suitable for Basic Sets 6 and 7

HxWxD: 780x570x960  
Weight unloaded approx. 85 kg

Storage of Alufix components in 6 clearly laid out, spacious and fully extendable drawers, also suitable for Alufix 40 Bars 80x80. Two top drawers are equipped with inlays for small components. Lower drawers equipped with non-slip mats.

Load capacity per drawer 75 kg



### Workstation, metal, lockable

#282727, suitable for Basic Sets 9 and extension sets

HxWxD: 780x570x1030  
Weight unloaded approx. 88 kg

Storage of Alufix components in 6 clearly laid out, spacious and fully extendable drawers, also suitable for Alufix 40 Bars 80x80. Additional storage compartment mounted at rear for safe storage of long bars and profiles 50x50. Two top drawers are equipped with inlays for small components. Lower drawers equipped with non-slip mats.

Load capacity per drawer 75 kg



### Storage compartment

#51753 for storage of long bars 50x50

HxWxD: 660x480x68 mm

Storage of long bars in 6 pockets.  
Assembly on rear of workstation with M8 screws included in supply.

---

**Information:**

- Weights mentioned in the catalogue are non-committal and approximate, and can deviate considerably i.e. through technical changes.
- We reserve the right to make technical changes.
- Where differences between photos and parts lists exist, the parts lists are decisive.
- Due to fluctuations of copper content in aluminum - alloy colour deviations may occur during anodizing.
- All Alufix components are also available anodized black e.g. for use with optical measuring systems. Exceptions are standard hard anodized items such as pins, connection elements in steel etc. These items maintain their usual characteristics but can be changed on request.
- All details on our products in this catalogue, especially illustrations, drawings, dimensions and statements on performance are to be regarded as approximate average values.
- We reserve the right to change design, technical data, dimensions and weights.
- The indicated standards, similar technical regulations as well as technical details, descriptions and illustrations are valid at time of printing.
- Our general trading conditions are valid.
- Our quotations are decisive.

**Germany****Witte Barskamp GmbH & Co. KG**

Horndorfer Weg 26-28  
D-21354 Bleckede

Germany

Tel.: +49 (0)5854/89-0

Fax: +49 (0)5854/89-40

E-mail:

[info@witte-barskamp.de](mailto:info@witte-barskamp.de)

[www.witte-barskamp.de](http://www.witte-barskamp.de)

**Asia****Witte Far East Pte Ltd**

20 Boon Lay Way # 01 – 170  
Singapore 609967

Singapore

Tel.: +65-6248 5961

Fax: +65-6898 4542

E-mail:

[info@witteasia.com](mailto:info@witteasia.com)

[www.witteasia.comAsia](http://www.witteasia.comAsia)

**USA & Canada****Witte LP**

2220 Northmont Pkwy, Suite 250  
Duluth, Georgia 30096

USA

Phone: +1 (770) 982 99 32

Fax: +1 (770) 982 99 28

E-mail:

[info@witteamerica.com](mailto:info@witteamerica.com)

[www.witteamerica.com](http://www.witteamerica.com)

**Mexico****Horst Witte de Mexico****S.A. de C.V., c/o Linco**

Paseo Opera 4 Int 112-2

Lomas de Angelopolis San Andres

Cholula, Puebla 72830, Mexico

Phone: +52(222)563-7929

E-mail:

[info@wittemexico.com](mailto:info@wittemexico.com)

[www.wittemexico.com](http://www.wittemexico.com)